

REV.	ECN NO.	CONTENT	DATE	ENGINEER
A0				

SPECIFICATIONS

Current Rating: 1.0 Amps
 Withstanding Voltage: AC 500V
 Insulation Resistance: 1000MΩ Min
 Contact Resistance: 20mΩ Max
 Operation Temperature: -40° to +105°
 Insulator Material: Polyester (UL94V-0)
 Contact Material: Brass
 Standard: PA6T
 Contact Plating: Gold Flash
 Max. Processing Temp: 240° C for 30-60 seconds
 (260° C for 5 seconds)

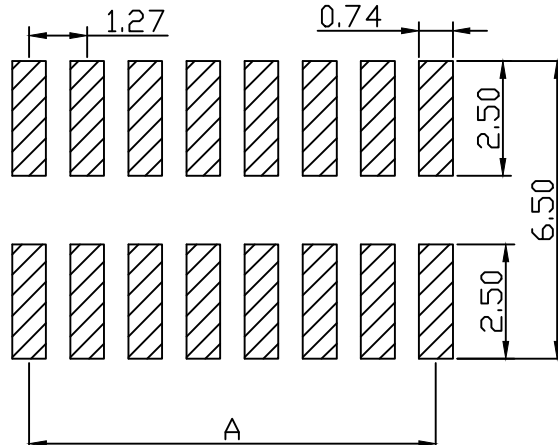
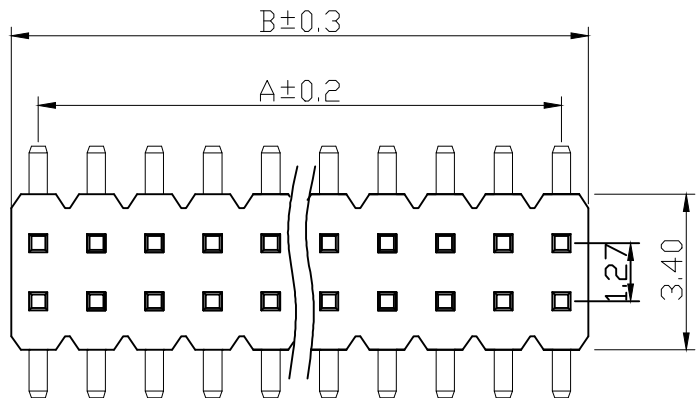

RECOMMEND P. C. B LAYOUT

PCB TOLERANCE: ±0.05 (TOP VIEW)

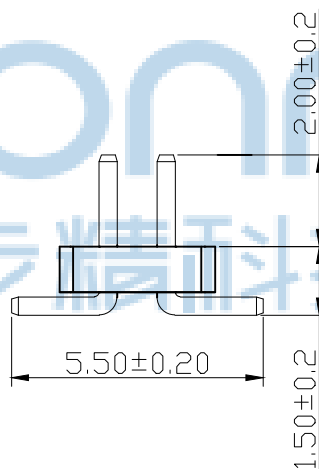
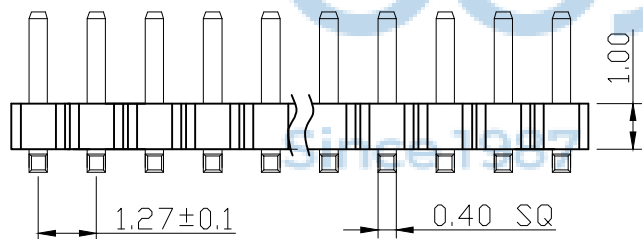

No. of	DIM. A	DIM. B	No. of	DIM. A	DIM. B	No. of	DIM. A	DIM. B	No. of	DIM. A	DIM. B	No. of	DIM. A	DIM. B
1	—	—	11	12.70	13.97	21	25.40	26.67	31	38.10	39.37	41	50.80	52.07
2	1.27	2.54	12	13.97	15.24	22	26.67	27.94	32	39.37	40.64	42	52.07	53.34
3	2.54	3.81	13	15.24	16.51	23	27.94	29.21	33	40.64	41.91	43	53.34	54.61
4	3.81	5.08	14	16.51	17.78	24	29.21	30.48	34	41.91	43.18	44	54.61	55.88
5	5.08	6.35	15	17.78	19.05	25	30.48	31.75	35	43.18	44.45	45	55.88	57.15
6	6.35	7.62	16	19.05	20.32	26	31.75	33.02	36	44.45	45.72	46	57.15	58.42
7	7.62	8.89	17	20.32	21.59	27	33.02	34.29	37	45.72	46.99	47	58.42	59.69
8	8.89	10.16	18	21.59	22.86	28	34.29	35.56	38	46.99	48.26	48	59.69	60.96
9	10.16	11.43	19	22.86	24.13	29	35.56	36.83	39	48.26	49.53	49	60.96	62.23
10	11.43	12.70	20	24.13	25.40	30	36.83	38.10	40	49.53	50.80	50	62.23	63.50

THIS DOCUMENT IS THE SOLE PROPERTY OF BBJconn Technology Co., Ltd. CORPORATION AND SHOULD NOT BE USED IN WHOLE OR IN PART WITHOUT PRIOR WRITTEN PERMISSION.

PDWG. NO: 0266-1

APPD. JM_Zheng
 CHKD. LYX
 DR. LHC

深圳市步步精科技有限公司

NAME: 排针 1.27PH H1.0 2x4P SMT W3.4
 PC5.5 PA2.0 PB1.5 L5.2 6T 波浪形 编带

PJ. NO.: PH.03.32-13-6004
 SIZE: A4 | DRW NO.:

FINISH: SEE NOTES | MAT'L.: SEE NOTES
 SCALE: N/A | REV.: A0 | UNIT: mm | PAGE: 1/1

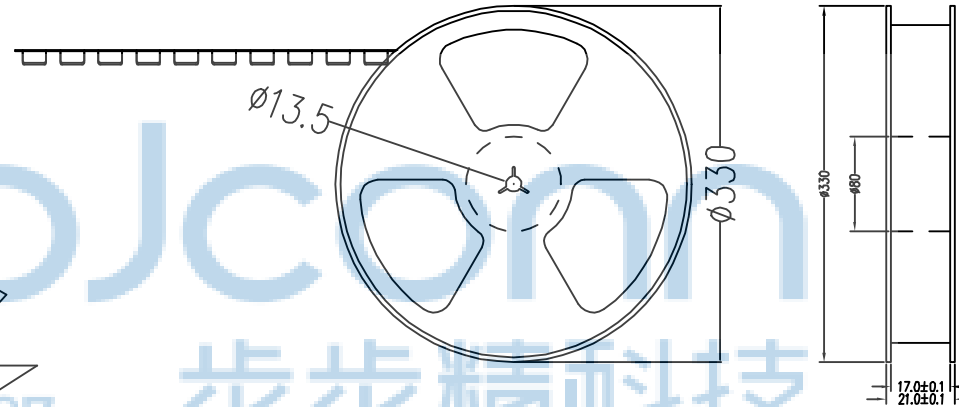
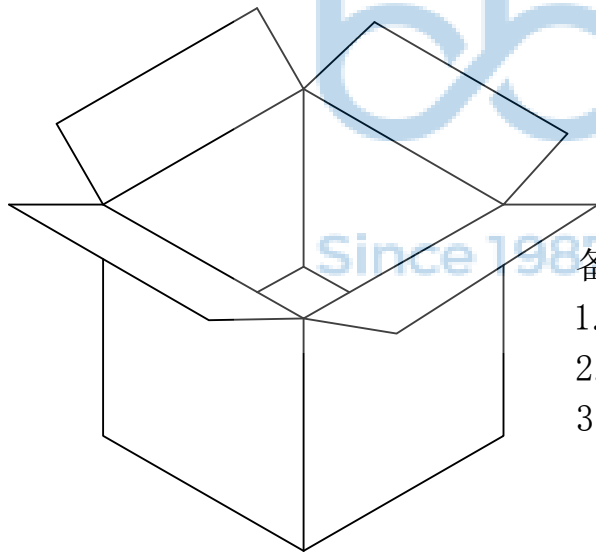
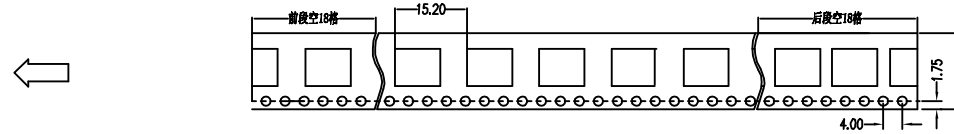
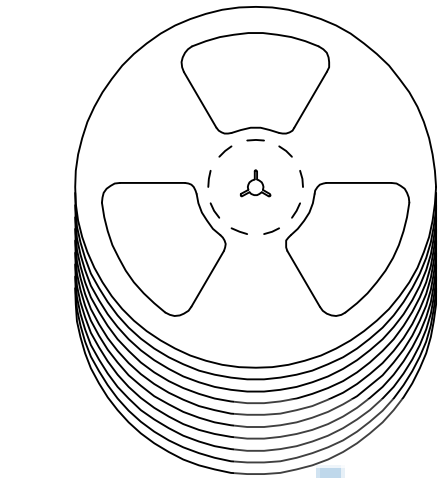

备注:

1. 包装数量: 700 /PCS/卷, 10卷/箱。
2. 包装袋长度: 每卷前后各空10-20个空格, 中间包装。
3. 材质:
载体: 聚丙烯 (PS), 阻抗 $10^{6-9} \Omega$
上带: 聚乙烯 (PET), 阻抗 $10^{6-11} \Omega$
卷盘: 聚苯乙烯。

纸箱规格: 345*345*23MM

纸箱规格: 345*345*35MM

THIS DOCUMENT IS THE SOLE PROPERTY OF BBJconn Technology Co.,Ltd. Corporation AND SHOULD NOT BE USED IN WHOLE OR IN PART WITHOUT PRIOR WRITTEN PERMISSION.		深圳市步步精科技有限公司 .X: ±0.38 .X': ±3' .XX: ±0.25 .X': ±2' .XXX: ±0.13 .XX': ±1'		NAME: 排针 1.27PH H1.0 2x4P SMT W3.4 PC5.5 PA2.0 PB1.5 L5.2 6T 波浪形 编带	
APPD.	JM_Zheng	PJ. NO.: PH.03.32-13-6004 SIZE: A4 DRW NO.:		FINISH: SEE NOTES MAT'L.: SEE NOTES	
CHKD.	LYX	SCALE: N/A		REV.: A0	UNIT: mm
PDWG.NO:	0266-1	DR.	LHC	PAGE: 2/2	