

REV	ECN NO	CONTENT	DATE	ENGINEER
A0		INITIAL RELEASE	/	SGF

NOTE:

- MECHANICAL PERFORMANCE,
 - INSERTION FORCE: 0.5~2.0kgf.
 - REMOVAL FORCE: 0.8kgf~2.0kgf.
 - DURABILITY: 10000 CYCLES.
- ELECTRICAL PERFORMANCE,
 - CURRENT RATING:5A
VOLTAGE RATING:20V
 - INSULATION RESISTANCE: 100MΩ MIN
 - DIELECTRIC WITHSTAND VOLTAGE,AC 100V FOR 1 MINUTE.
 - LOW CONTACT RESISTANCE: INITIAL 40mΩ, AFTER 50mΩ.
- ENVIRONMENTAL PERFORMANCE:
OPERATING TEMPERATURE: -30°C~+80°C.
THE PEAK TEMPERATURE ON THE BOARD SHALL
- IR REFLOW:
BE MAINTAINED FOR 10 SECONDS AT 260°C.

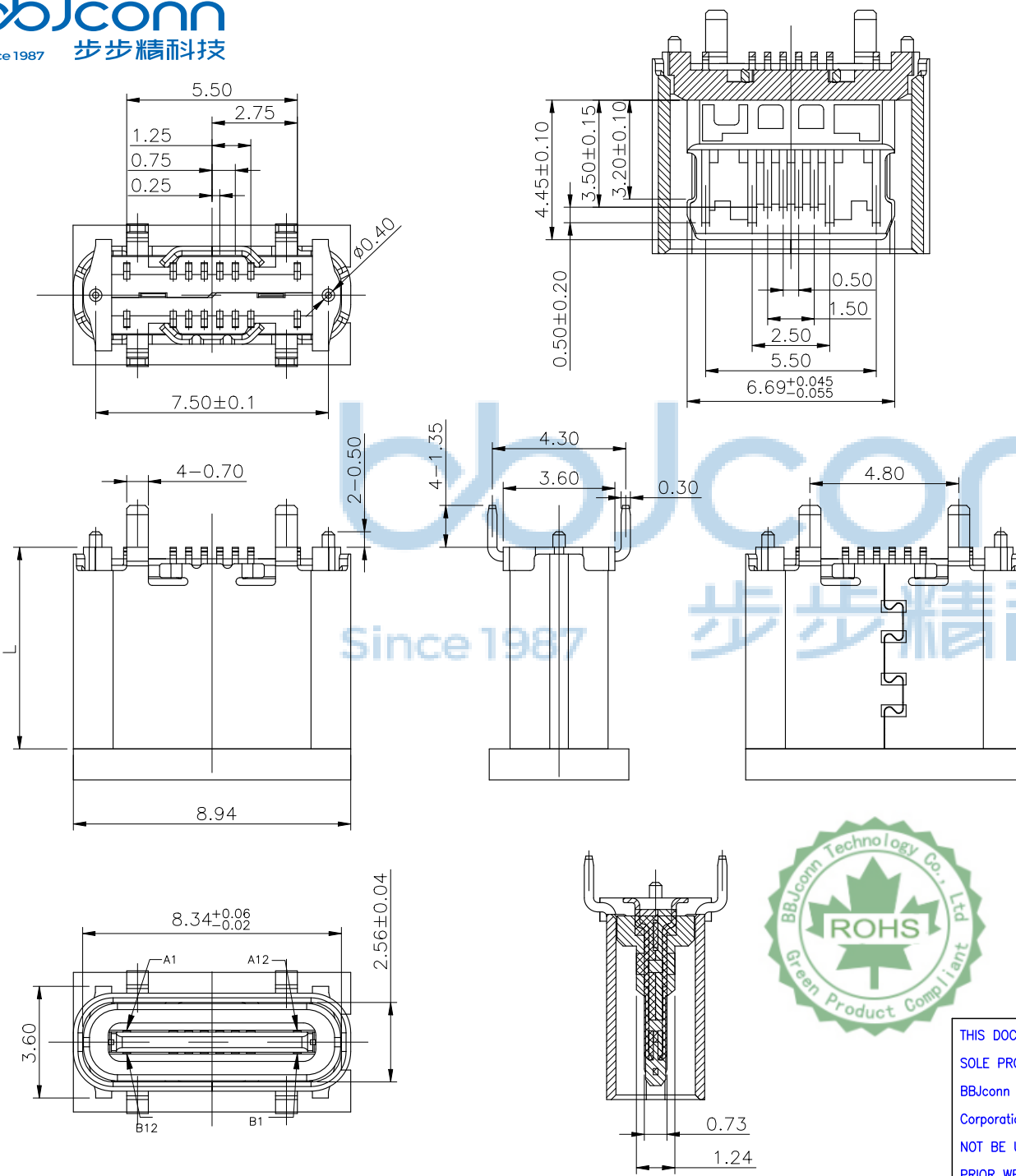

L (mm)	5.5	6.5	6.8	7.4
--------	-----	-----	-----	-----

NO.	DESCRIPTION	MATERIAL	REMARKS	
5	CAP	LCP UL94V-0	BLACK	1PCS
4	OUTER SHELL	SUS304 T=0.30MM	NI 30u"MIN	1PCS
3	SHIELDING PLATE	SUS301 T=0.15MM	N/A	1PCS
2	CONTACT	C2680 T=0.15MM	Mating area 1u"Au Solder Tails:G/F Underplate: 50u"Min Ni overall	2SET
1	INSERT MOLDING	LCP UL94V-0	BLACK	1PCS

THIS DOCUMENT IS THE SOLE PROPERTY OF BBJconn Technology Co.,Ltd. Corporation AND SHOULD NOT BE USED IN WHOLE PRIOR WRITTEN PERMISSION.

PDWG NO: 0100-2

深圳市步步精科技有限公司

NAME: TYPE-C 16P 母座 直立式 四脚插 端子SMT 无弹 带柱 H=7.40 大脚(脚长1.35) 编带

PJ NO: 126-224-160008-V2G

SIZE:A4 DRW NO:

FINISH:SEE NOTES MAT'L:SEE NOTES

SCALE:N/A REV:A0 UNIT:mm PAGE:1/3

APPD: JM_Zheng

CHKD: LYX

DR: SGF

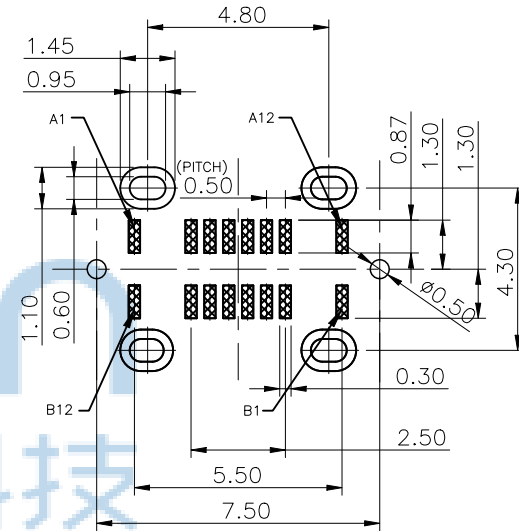
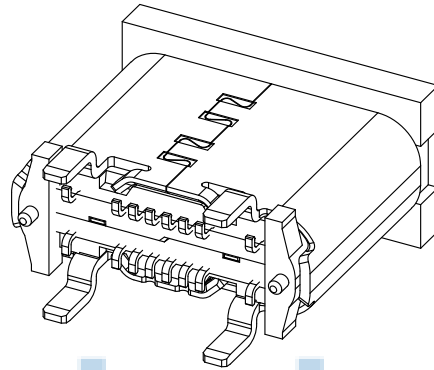

USB TYPE-C PIN ASSIGNMENTS

PIN NUMBER	SIGNAL NAME	PIN NUMBER	SIGNAL NAME
A1	GND	B12	GND
A4	VBUS	B9	VBUS
A5	CC1	B8	SBU2
A6	Dp1	B7	Dn2
A7	Dn1	B6	Dp2
A8	SBU1	B5	CC2
A9	VBUS	B4	VBUS
A12	GND	B1	GND



THIS DOCUMENT IS THE
SOLE PROPERTY OF
BBJconn Technology Co.,Ltd.
Corporation AND SHOULD
NOT BE USED IN WHOLE
PRIOR WRITTEN PERMISSION.

深圳市步步精科技有限公司

.X: ±0.38 X': ±3"
.XX: ±0.25 .X': ±2"
.XXX: ±0.13 .XX': ±1"

NAME: TYPE-C 16P 母座 直立式 四脚插 端子SMT
无弹 带柱 H=7.40 大脚(脚长1.35) 编带

APPD JM_Zheng

PJ NO: 126-224-160008-V2G

CHKD LYX

SIZE:A4 DRW NO:

DR SGF

FINISH:SEE NOTES MAT'L:SEE NOTES

PDWG NO:0100-2

SCALE:N/A REV:A0 UNIT:mm PAGE:2/3



REV	ECN NO	CONTENT	DATE	ENGINEER
AO		INITIAL RELEASE	/	SGF

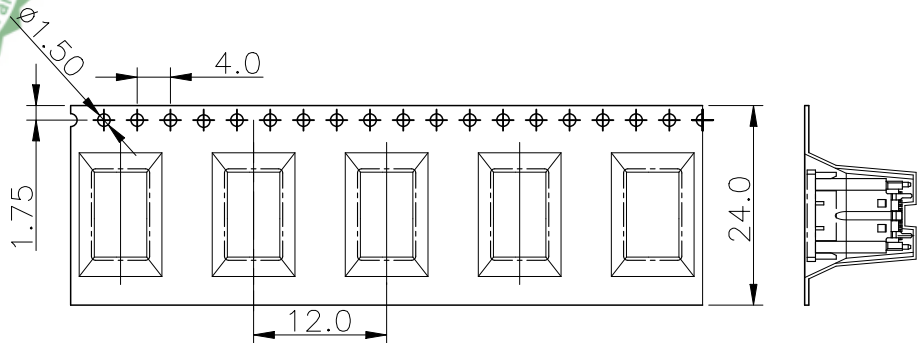
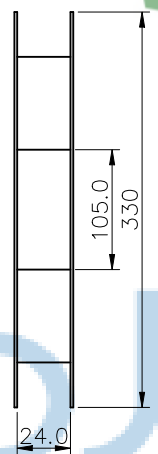
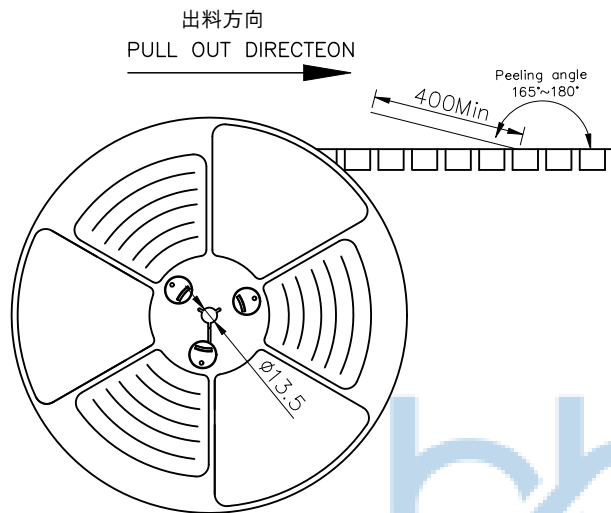

NOTES

- 帶子引導長度
LEAD TAPE LENGTH
出料方向
PULL OUT DIRECTION

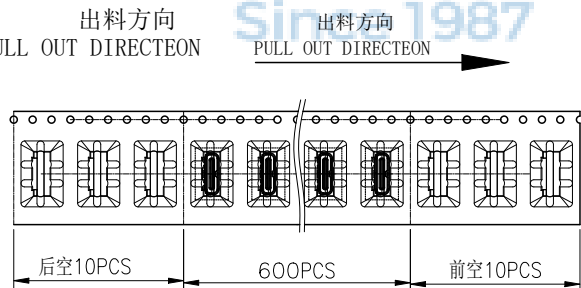

- 上帶 剝力力為: 0.1~1.3N(10.2gf~130gf)
PEELING OFF FORCE OF TOP TAPE: 0.1~1.3N(10.2gf~130gf)
出貨'運輸過程中一定注意:
THIS REQUIREMENT SHOULD BE APPLIED AT SHIPMENT:
卷帶在運輸過程中不能散開
PEELING OFF SHOULD NOT BE ALLOWED DURING TRANSPORTATION

TAPE & REEL 10 PCS

1 REEL = 600 PCS

BOX

DIMENSIONS:
33.5X33.5X30.5

1 CARTON
= 10 REELS
= 6000 PCS



THIS DOCUMENT IS THE
SOLE PROPERTY OF
BBJconn Technology Co.,Ltd.
Corporation AND SHOULD
NOT BE USED IN WHOLE
PRIOR WRITTEN PERMISSION.
PDWG NO: 0100-2

深圳市步步精科技有限公司		NAME: TYPE-C 16P 母座 直立式 四脚插 端子SMT 无弹 带柱 H=7.40 大脚(脚长1.35) 编带	
.X: ±0.38 .XX: ±0.25 .XXX: ±0.13	X': ±3" .X': ±2" .XX': ±1"	APPD: JM_Zheng	PJ NO: 126-224-160008-V2G
CHKD: LYX	DR: SGF	SIZE:A4	DRW NO:
SCALE:N/A		REV:AO	UNIT:mm
FINISH:SEE NOTES		MAT'L:SEE NOTES	
PAGE:3/3			

包装明细表 (The detail of the packing)					
包装容量 (Packing Capacity)			重量 Weight (Kg)		
pcs/box	boxs/Carton	Pcs/Box	N.W./Pcs	N.W./Box	G.W./Box
600	10	6000	----	----	----